

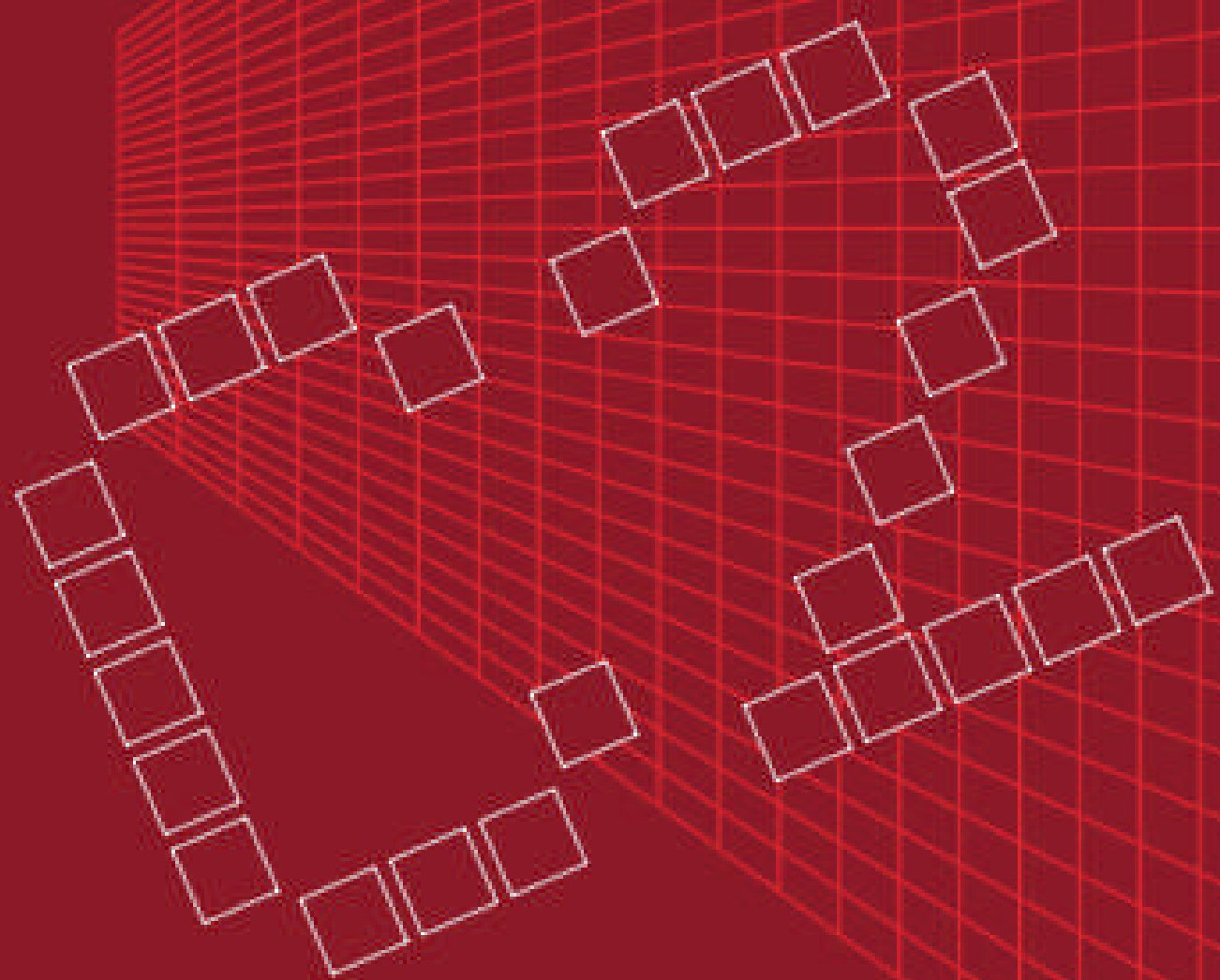

User Guide

CC-300
CORIOconsole
Operation Manual

Version 1.5



CC-300 CORIOconsole Operation Manual

Version 1.5



CC-300 CORIOconsole Operation Manual

Table of Contents

1.0	Disclaimer	4
1.1	Regulatory Agency Acceptance.....	4
1.2	FCC Statement.....	4
2.0	IMPORTANT SAFETY INSTRUCTIONS	6
3.0	CAPABILITY, TERMS OF REFERENCE AND OVERVIEW SUMMARY	16
3.1	Device Capabilities	16
4.0	UNPACKING AND INSTALLATION.....	17
4.1	Shipping Carton.....	17
4.2	Furnished Accessories.....	17
5.0	FUNCTIONAL CHECK	18
5.1	Important Safety Instructions	18
5.2	Factory Reset	19
5.3	Initial Operation Check Using Factory Default Settings	19
5.4	Manual configuration of connection.....	22
5.5	Auto IP Detection	24
5.6	Calypso controller configuration.....	24
5.7	Locking the keyboard.....	27
5.8	Standby mode	27
5.9	Connection problems?	28
6.0	CC-300 IN OPERATION.....	30
6.1	Navigation.....	30
7.0	RETURN PROCEDURE	31
7.1	To return a unit for repair	31
7.2	TECHNICAL SUPPORT	32
8.0	WARRANTY POLICY	33
9.0	Connector pinouts	34
9.1	Ethernet connector	34
9.1.1	Straight through cable.....	34
9.1.2	Crossover cable.....	34
9.2	Power connector.....	34
9.3	RS232 / DB9 connector	34
10.0	Specification	35
10.1	Control Methods	35
10.2	Mechanical	35

CC-300 CORIOconsole Operation Manual

10.3	Environmental.....	35
11.0	Contact Information.....	36

1.0 DISCLAIMER

This product is intended for professional and/or home use. This product is not intended for use in a medical environment and does not have the required certifications for such use. Similarly, use aboard any aircraft or spacecraft while in flight or as an adjunct to any surface, airborne or marine navigation system or any offshore marine activity, including control of any watercraft, or any use similar to those specifically herein mentioned is prohibited. Use in the aforementioned circumstances would require additional testing and certification.

You have not become the owner of any software - you have merely purchased the right to use the software. You may make one copy of the software for your own use. Other copies will be deemed a breach of copyright.

No warranty is made either expressed or implied including but not limited to any implied warranties of merchantability or fitness for a particular purpose. In no event shall the supplier or manufacturer of this product be liable for errors found within, or be liable for any direct, indirect or consequential damages or loss in connection with the purchase or use of this hardware software or manual. The sole and exclusive liability to the supplier and manufacturer regardless of the form of action shall not exceed the replacement cost of the materials described herein.

By using this equipment you have indicated that you have agreed to the terms listed above. If you do not wish to agree or the above terms are contrary to your conditions of purchase you may return the equipment, unused, to your supplier. All trademarks and copyrights are acknowledged. E&OE.

1.1 Regulatory Agency Acceptance

European 'CE' Mark Statement

Emissions: BS EN 61000-6-1:2001 (Generic Immunity Standard for Residential, Commercial and Light Industrial)

Immunity: BS EN 61000-6-3:2001 (Generic Immunity Standard for Residential, Commercial and Light Industrial)

1.2 FCC Statement

Class A Device: This equipment has been tested and found to comply with the limits for a Class A digital device pursuant to Part 15 of the FCC Rules. These limits are designed to provide a reasonable protection against harmful interference when the equipment is operated in a commercial environment. This equipment generates, uses and can radiate radio frequency energy and, if not installed and used in accordance with the Instruction Manual, may cause harmful interference to radio communications. Operation of this equipment in a residential area is likely to cause harmful interference in which case the user will be required to correct the interference at his own expense.

CC-300 CORIOconsole Operation Manual

Caution: This equipment is intended for use in the manner prescribed in the Instruction Manual. Any user changes or modifications not expressly approved by TV One Multimedia Solutions could void the user's authority to operate the equipment. Connecting this equipment to external devices requires no specially shielded cabling for FCC compliance. The Instruction Manual shows or describes the proper connection of this equipment for operation that insures FCC compliance.

Direct all inquiries regarding FCC compliance to:

TV One Multimedia Solutions
1350 Jamike Drive
Erlanger, KY 41018
859.282.7303
859.282.8225 (Fax)

Manual Version Information

Version: 1.5
Release Date: May, 2009

Manual Copyright Notice

This Operation Manual is the intellectual property of TV One, ©2006. No portion of this manual may be copied or reproduced in any manner or by any means, including, but not limited to electronic and electro-mechanical, without the express written permission of TV One.

2.0 IMPORTANT SAFETY INSTRUCTIONS

To insure the best from this product, please read this manual carefully. Keep it in a safe place for future reference.

To reduce the risk of electric shock, do not remove the cover from the unit. No user serviceable parts inside. Refer servicing to qualified personnel.

2.1 Power and connections

This unit is not disconnected from the AC power source as long as it is connected to the wall outlet. The off state for this unit is called standby mode. In standby mode the unit is designed to consume a reduced quantity of power compared to normal operating modes.

When not using the unit for a long period of time, insure that the AC power cord is disconnected from the wall outlet.

The AC wall outlet should be installed near to the unit and be easily accessible.

Do not plug in or attempt to operate an obviously damaged unit.

2.2 Water and moisture

To reduce the risk of fire and personal injury, operation of this device outdoors and/or exposure to rain, water or excessive moisture is expressly prohibited.

The apparatus shall not be exposed to dripping or splashing and no objects filled with liquids, such as vases, shall be placed on the apparatus.

2.3 General care

Do not force switches or external connections.

When moving the unit, disconnect the serial port connections first then the power cable and finally the interconnecting cables to other devices.

Do not attempt to clean the unit with chemical solvents or aerosol cleaners, as this may damage the unit. Use a clean dry cloth.

2.4 Location

Installation of this unit should be in a cool dry place, away from sources of excessive heat, vibration, dust, moisture and cold.

2.5 Intellectual property

Some IC chips in this product include confidential and/or trade secret property. Therefore you may not copy, modify, adapt, translate, distribute, reverse engineer, reverse assemble or decompile the contents thereof.

2.0 IMPORTANT: CONSIGNES DE SECURITE

Afin de tirer le meilleur de ce produit, merci de lire attentivement ce manuel. Gardez-le dans un endroit sûr pour pouvoir le consulter à nouveau.

Afin de réduire le risque de choc électrique, ne retirez pas l'unité de sa protection.

Aucune pièce réparable par l'utilisateur à l'intérieur. Référez-vous à des personnes qualifiées.

2.1 Alimentation électrique et connexions

Cette unité n'est pas déconnectée de la source de courant électrique tant qu'elle est connectée à la prise murale. Le mode éteint de cette unité est appelé mode de veille. En mode de veille, cette unité est conçue pour consommer une quantité réduite de courant par rapport aux modes normaux d'utilisation.

Lorsque vous n'utilisez pas l'unité pendant une longue période, assurez-vous que le câble d'alimentation électrique est déconnecté de la prise murale.

La prise murale de courant doit être installée près de l'unité et aisément accessible.

Ne branchez pas et n'essayez pas d'utiliser une unité visiblement endommagée.

2.2 Eau et humidité

Pour réduire les risques d'incendie et de dommages corporels, l'utilisation de cet appareil à l'extérieur et/ou son exposition à la pluie, l'eau ou une humidité excessive est expressément interdite.

L'appareil ne doit pas être exposé aux gouttes ou aux éclaboussures et aucun objet contenant de l'eau, comme par exemple un vase, ne doit être posé sur l'appareil.

2.3 Entretien général

Ne forcez pas les boutons ou connexions externes.

Lorsque vous déplacez l'unité, déconnectez d'abord les connexions de ports en série puis le câble d'alimentation et enfin les câbles de connexion avec d'autres appareils.

N'essayez pas de nettoyer l'unité avec des dissolvants chimiques ou des produits nettoyants en aérosol, car cela peut endommager l'unité. Utilisez un chiffon propre et sec.

2.4 Emplacement

L'installation de cette unité doit se faire dans un endroit frais et sec, éloigné de sources excessives de chaleur, de vibrations, de poussière, d'humidité et de froid.

2.5 Propriété intellectuelle

Certaines puces IC dans ce produit contiennent des éléments propriétaires confidentiels et/ou des secrets commerciaux. Vous ne devez donc pas copier, modifier, adapter, traduire, distribuer, démonter, désassembler, ou décomposer leur contenu.

2.0 INSTRUCCIONES IMPORTANTES DE SEGURIDAD

Para sacar el mejor provecho de este producto, léase este manual con detenimiento. Guárdelo en un lugar seguro para poder hacerle referencia en el futuro.

Para reducir el riesgo de calambre, no quite la cubierta del aparato.

No hay piezas utilizables dentro. Remítase todo mantenimiento a personal cualificado.

2.1 Corriente y conexiones

Mientras esté conectada a una toma de electricidad, el aparato seguirá conectado a la fuente de corriente CA. A la posición de «off» de este aparato se le denomina posición de espera. En la posición de espera, el aparato está diseñado a consumir una cantidad reducida de electricidad en comparación con los modos de operación normales.

Asegúrese de desconectar el cable de corriente CA de la toma de la pared cuando no va a utilizar el aparato por un periodo largo de tiempo.

La toma CA de la pared ha de estar instalada cerca del aparato y debe ser fácilmente accesible.

No enchufe ni intente operar un aparato que esté evidentemente dañado.

2.2 Agua y humedad

Para reducir el riesgo de fuego o de daños personales, se prohíbe la utilización de este aparato en el exterior y/o su exposición a la lluvia, al agua o a atmósferas de excesiva humedad.

El aparato no debe situarse cerca de zonas en las que haya riesgo de goteo o salpicaduras. Tampoco deben colocarse objetos que contengan agua (jarrones, por ejemplo) en el mismo.

2.3 Cuidado general

No forzar interruptores o conexiones externas.

Al mover el aparato, desconecte las conexiones del puerto en serie primero, luego el cable de electricidad y finalmente los cables interconectados a otros aparatos.

No intente limpiar el aparato con disolventes químicos o productos de limpieza aerosol, ya que podrían dañar el aparato. Utiliza un paño limpio y seco.

2.4 Ubicación

Este aparato se debe instalar en un lugar seco y fresco, lejos de fuentes de calor excesivas, la vibración, el polvo, la humedad y el frío.

2.5 Propiedad intelectual

Algunos chips con circuito integrado de este producto incluyen propiedad confidencial y/o propiedad de secreto comercial. Por lo tanto queda prohibido copiar, modificar, adaptar, traducir, distribuir, usar técnicas retroactivas, desmontar, o recopilar los contenidos del mismo.

2.0 WICHTIGE SICHERHEITSVORSCHRIFTEN

Lesen Sie diese Bedienungsanleitung bitte sorgfältig, um Ihr Produkt optimal nutzen zu können, und bewahren Sie sie zum späteren Nachschlagen an einem sicheren Ort auf.

Entfernen Sie bitte keinesfalls die Abdeckung, um der Gefahr eines Stromschlags vorzubeugen.

Im Inneren des Geräts befinden sich keine Teile, die vom Benutzer gewartet werden können. Lassen Sie Wartungsarbeiten nur von Fachpersonal durchführen.

2.1 Stromversorgung und anschlüsse

Solange das Gerät mit einer Steckdose verbunden ist, bleibt die Stromversorgung aufrecht. Der Ausschaltzustand des Geräts wird als Standbymodus bezeichnet. Im Standbymodus verbraucht das Gerät weniger Strom als in den üblichen Betriebsarten.

Wird das Gerät über einen längeren Zeitraum hinweg nicht verwendet, ziehen Sie bitte das Stromkabel aus der Steckdose.

Die Steckdose sollte sich in der Nähe des Geräts befinden und leicht zugänglich sein.

Verbinden Sie ein offensichtlich beschädigtes Gerät keinesfalls mit einer Steckdose und versuchen Sie auch nicht, es zu bedienen.

2.2 Wasser und feuchtigkeit

Um die Gefahr eines Brandes oder einer Körperverletzung zu verringern, ist es ausdrücklich verboten, dieses Gerät im Freien in Betrieb zu nehmen und/oder es Regen, Wasser oder hoher Feuchtigkeit auszusetzen.

Das Gerät darf keinen Tropfen oder Spritzern ausgesetzt werden und es dürfen keine mit Flüssigkeiten gefüllte Behälter, wie Vasen, auf das Gerät gestellt werden.

2.3 Allgemeine pflege

Wenden Sie bei der Handhabung von Schaltern und Anschlüssen keine Gewalt an.

Beim Umstellen des Geräts entfernen Sie zuerst die seriellen Anschlüsse, dann das Stromkabel und zum Schluss die Verbindungskabel zu anderen Geräten.

Versuchen Sie keinesfalls, das Gerät mit chemischen Lösungsmitteln oder Sprayreinigern zu reinigen, da dies das Gerät beschädigen könnte. Verwenden Sie ein sauberes, trockenes Tuch.

2.4 Aufstellung

Das Gerät sollte an einem kühlen, trockenen Ort aufgestellt werden, fern von übermäßiger Wärme, Vibrationen, Staub, Feuchtigkeit und Kälte.

2.5 Gewerbliches eigentum

Einige integrierte Schaltkreise in diesem Produkt enthalten vertrauliche

Informationen und/oder Betriebsgeheimnisse. Sie dürfen daher diese Inhalte nicht kopieren, modifizieren, adaptieren, übersetzen, verteilen, rückentwickeln, rückassemblieren oder dekompileieren.

2.0 BELANGRIJKE VEILIGHEIDSINSTRUCTIES

Lees deze handleiding zorgvuldig door om het beste uit uw product te halen. Bewaar het op een veilige plek voor raadpleging in de toekomst.

Haal nooit het omhulsel van de eenheid af, dit om de kans op een elektrische schok te verminderen. Maak het apparaat nooit open: er bevinden zich geen door de gebruiker in te stellen onderdelen in het apparaat. Laat service en onderhoud over aan een gekwalificeerde technicus.

2.1 Elektriciteit en aansluiting

Deze eenheid is niet van de wisselstroom voedingsbron gescheiden wanneer de stekker nog in het stopcontact zit. Wanneer de eenheid uitstaat, staat deze nog in de stand-by modus. In de stand-by modus vergt de eenheid minder stroom dan in de normale "aan" modus.

Wanneer u de eenheid voor langere tijd niet gebruikt, zorg er dan voor dat de stekker van het wisselstroomsnoer uit het stopcontact is getrokken.

Het wisselstroom stopcontact moet dichtbij de eenheid geïnstalleerd worden en makkelijk toegankelijk zijn.

Als de eenheid duidelijk beschadigd is moet u deze nooit op het lichtnet aansluiten of bedienen.

2.2 Water en vocht

Om het risico op brand en persoonlijk letsel te beperken is het gebruik van dit apparaat buiten en/of blootstelling aan regen, water of overdadige hoeveelheden vocht uitdrukkelijk verboden.

Het apparaat mag niet worden blootgesteld aan druppels of bespatting en er mogen geen objecten die gevuld zijn met vloeistoffen, zoals vazen, op het apparaat geplaatst worden.

2.3 Algemeen onderhoud

Forceer schakelaars of externe aansluitingen nooit.

Bij verplaatsing van de eenheid, de seriële poortansluitingen eerst loskoppelen, dan de voedingskabel en als laatste de snoeren naar andere apparaten.

Probeer de eenheid nooit met chemische oplosmiddelen of schoonmaakmiddelen in een spuitbus schoon te maken, omdat dit de eenheid kan beschadigen. Gebruik een schone droge doek.

2.4 Plaatsing

Deze eenheid moet geïnstalleerd worden op een koele droge plaats, uit de buurt van bronnen van extreme hitte, vibraties, stof, vocht en kou.

2.5 Intellectueel eigendom

Sommige IC chips in dit product bevatten vertrouwelijke informatie en/of fabrieksgeheimen. U mag daarom de inhoud hiervan niet kopiëren, wijzigen, aanpassen, vertalen, verspreiden, nabouwen, of decompileren.

3.0 CAPABILITY, TERMS OF REFERENCE AND OVERVIEW SUMMARY

3.1 Device Capabilities

The CC-300 CORIOconsole provides a Video Production Switcher type interface for the C2 series of Dual Video Processors and Calypso controllers. Two rows of 14 buttons are provided for Preview and Program functionality of mixed format sources. Fades and wipes may be either automatic with preset times or manually controlled via the fader bar. The joystick employs full range of motion to allow precise positioning of P-I-P inserts and other functions. Fixed purpose function keys along with the integrated LCD screen combined with “soft” function keys provides total control over a single C2 series unit using a RS232 link or over multiple C2 series units using an IP link.

At home in both broadcast and display environments, the CC-300 CORIOconsole provide access to all controls with a minimum of keystrokes giving fast access to the powerful CORIO2 features.

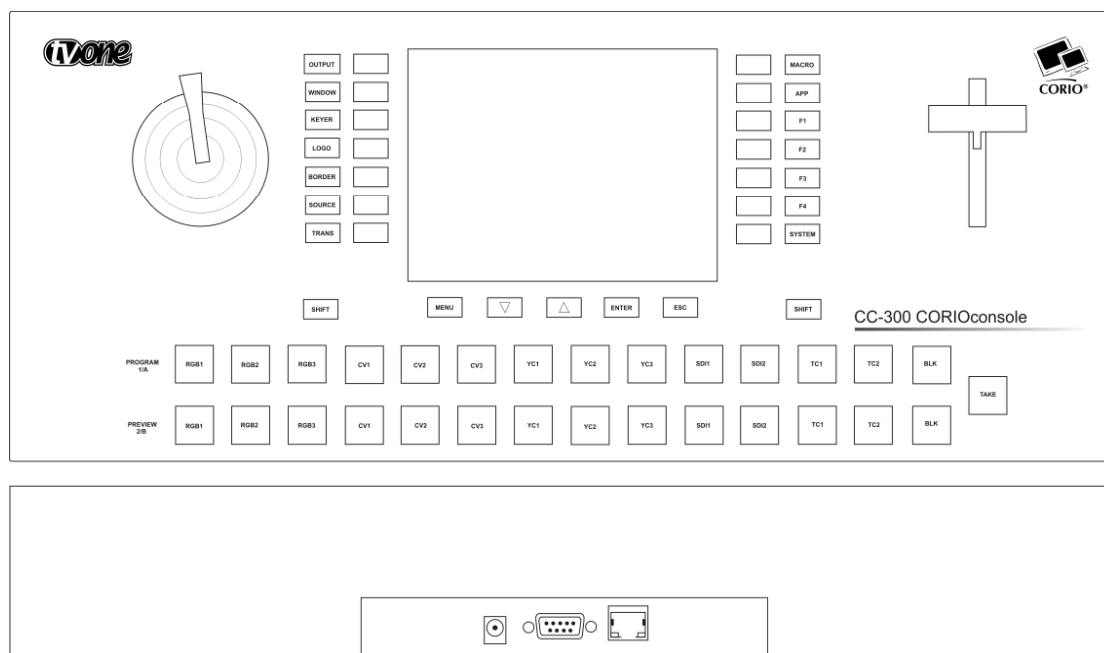

Fig 1. Line drawing of the CC-300 CORIOconsole

Four connectors are available at the rear of the unit. A locking 12 volt DC connector supplies the power for the console. Simple connection to multiple Video Processors is supported by connecting through a local area network using the IP socket. A RS232 connector provides a method to download firmware upgrades from a PC computer and allows control of a single Video Processor using the supplied serial cable. An option socket is provided for future expansion of controller facilities.

A single Video processor can also be controlled directly by connecting a network crossover cable (see 9.1.2 for connection details) between the IP sockets of the CC-300 CORIOconsole and the Video Processor.

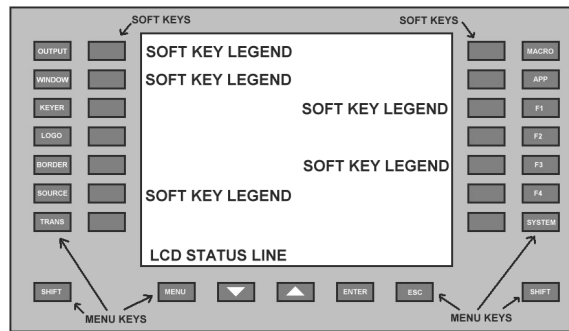

Fig 2. Location of keys and legends

Throughout this manual reference is made to Menu keys, Softkeys and legends, Fig 2 shows the position on the console of these keys along with the location of the status line at the bottom of the LCD screen.

4.0 UNPACKING AND INSTALLATION

4.1 Shipping Carton

The CC-300 CORIOconsole arrives double boxed for maximum protection during shipping. You are encouraged to retain both boxes and all packing material so the unit can be returned in the unlikely event that repairs should ever become necessary.

4.2 Furnished Accessories

Carefully unpack the carton and perform an inventory of the contents. In addition to the CC-300 CORIOconsole, the standard accessories include:

- 1 AC Power Cable
- 1 12V 4Amp DC power supply
- 1 Operations Manual
- 1 Rackmount Kit, 2 Ears and 8 Screws

If any items are missing or defective, contact your supplier. If you are unable to resolve the problem with your supplier, contact TV One via the web at <http://www.tvone.com/support> for prompt replacement.

5.0 FUNCTIONAL CHECK

5.1 Important Safety Instructions

The AC power cable (Mains Lead) furnished with the unit will conform to the type in use at your geographic locale. Please compare the plug on your cable with the three types of power cable plugs currently being shipped to make certain you have received the correct power cable.

If you did not receive the correct cable, **DO NOT** attempt to modify the incorrect cable. Instead, immediately contact your dealer or contact TV One at the sales office nearest to your geographic location and request the proper cable.

US AC Cable Plug Example:

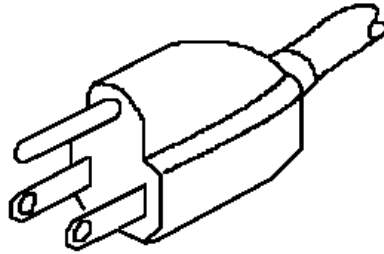

UK AC Mains Lead Plug Example:

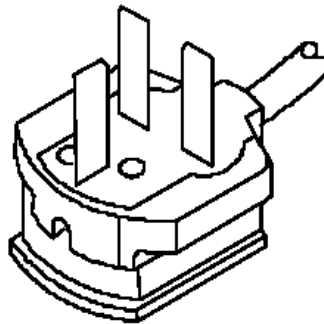

EU AC Mains Lead Plug Example:

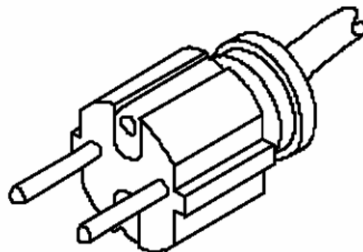

CC-300 CORIOconsole Operation Manual

AGAIN, **DO NOT** ATTEMPT TO MODIFY AN INCORRECT AC CABLE (MAINS LEAD). REPLACE IT WITH A CORRECT PART PRIOR TO USING THE CC-300 CORIOconsole.

Power is never totally removed from the unit when it's plugged into an active AC outlet. Selecting Standby from the system menu only places the unit in a powered down mode. Pressing the 'TAKE' button will bring the unit out of standby and restart the console as if the power had been recycled. This is not a true off and on switch.

Never remove the unit from a cabinet unless the unit has been completely disconnected from AC power.

5.2 Factory Reset

To restore all operational parameters to their original condition, select 'Restore defaults' from the system menu then press ENTER to confirm.

All stored settings are lost when the unit is reset.

A Firmware update will also perform a complete factory reset

5.3 Initial Operation Check Using Factory Default Settings

All the examples in this manual are given with relation to the setup illustrated in the picture below: A CC-300 CORIOconsole, a TVOne C2-7100 video processor and a Calypso ION-LT2 control unit are all connected to a local network; the IP address, subnet and port settings of each individual unit are shown in the picture.

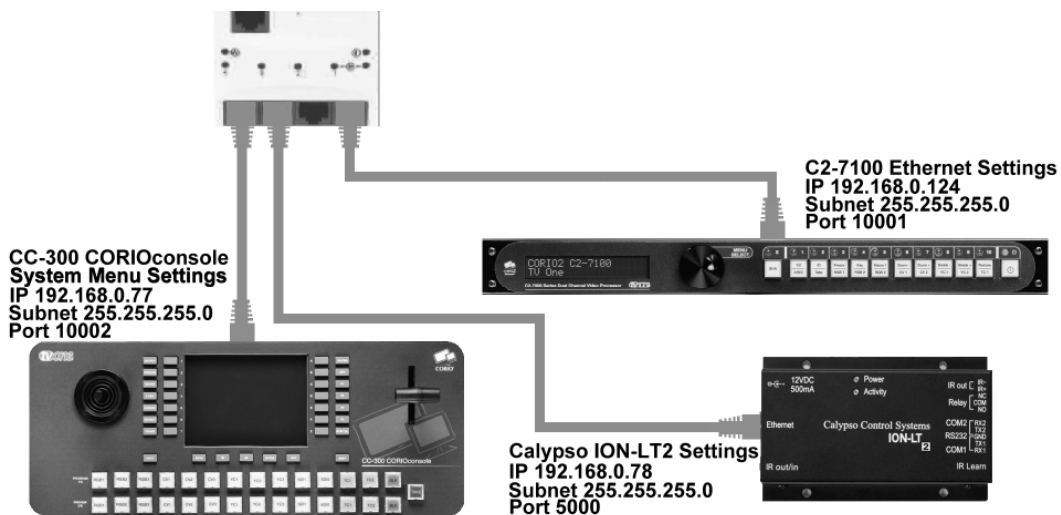

Connect the 12v power supply into the socket on the back of the CC-300 CORIOconsole, this should be locked into position by rotating the connector clockwise after insertion. Connect the AC power cable to the 12volt power supply and turn on the power.

CC-300 CORIOconsole Operation Manual

The program/preview keys will light in sequence while the unit initializes and the LCD will display the TVOne logo. As this is the first time of operation following a factory reset, the console will not do anything until the CC-300's own configuration has been setup.

Wait until the connection screen is displayed as shown in Fig 3:

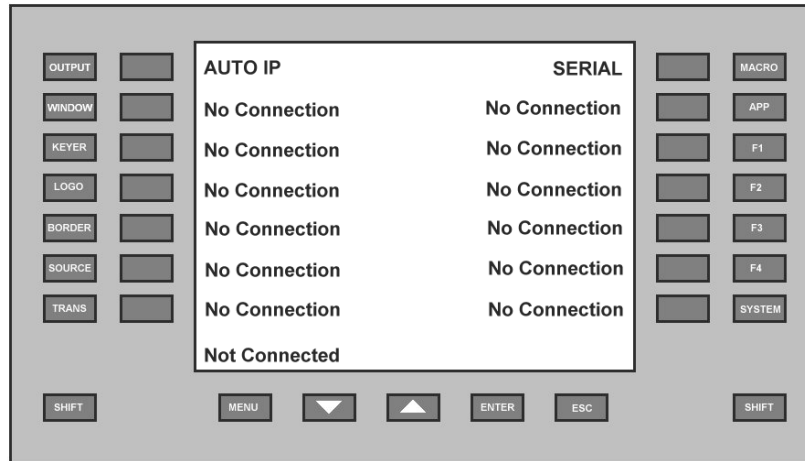

Fig 3. The Connection Menu

Then Press the system key to display the system menu.

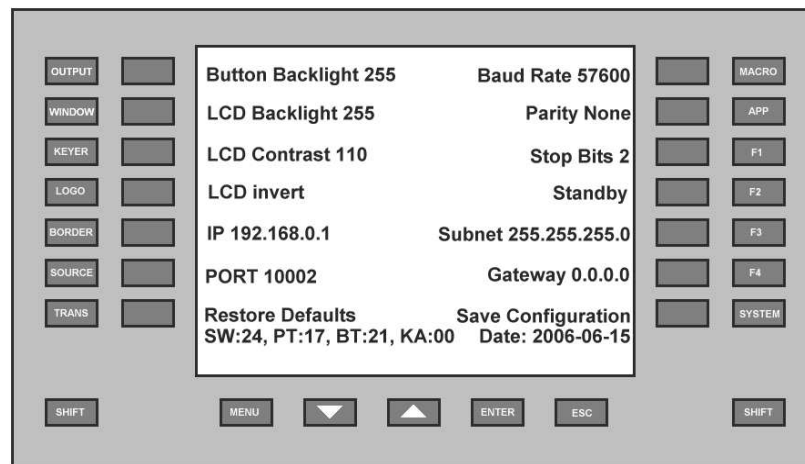

Fig 4. The System Menu

Change the settings to suit your network or serial protocol. This is achieved by pressing the soft key next to the item to change. Flashing brackets will surround the item which can then be altered using either the T-Bar or the up and down arrow keys. The preferred adjustment method is indicated in the status line at the bottom of the LCD display.

The up/down key will auto repeat if held down and will also increase in speed with time while the key is held. Items with multiple values will shift to the next value on each press of the soft key next to the item to change

CC-300 CORIOconsole Operation Manual

The ENTER key will extinguish the brackets and set the value or the ESC key will extinguish the brackets and restore the original value. The values set may not remain in the event of a power cycle unless the settings are made permanent by selecting 'Save configuration' and then press ENTER to confirm your choice.

In our example setup the IP needs to be set to 192.168.0.78, the subnet and port default settings already match our requirements.

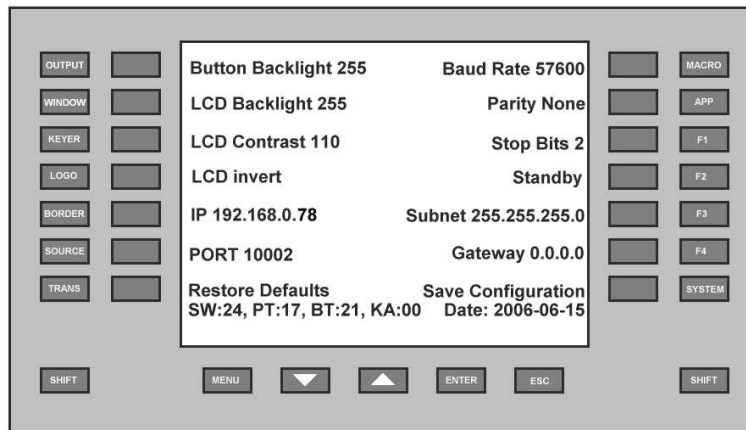

Fig 5. System menu for our example setup

Next either connect the CC-300 CORIOconsole to the Video Processors using the serial cable provided or connect the CC-300 CORIOconsole and all Video Processors to be controlled to your local area network using the IP sockets with appropriate cables. Consult your network administrator to ensure that each Video Processor is configured with a different IP address and the SUBNET matches your network configuration.

Once the settings have been chosen and stored, Press the ESC key to show the Connection Menu.

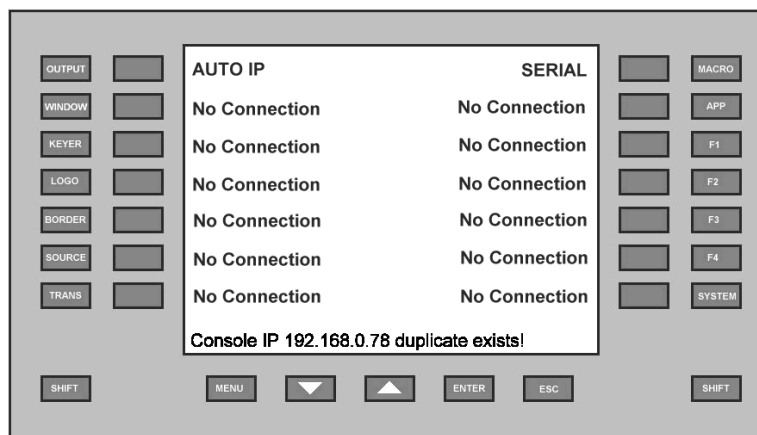

Fig 6. Connection Menu showing a duplicate IP has been detected

If the console is connected to the network it will warn you within a minute if another device with the same IP address is connected as shown in fig 6. Return to the system menu to change your settings if this occurs.

The connection menu will allow you to connect up to 12 external TV One Video Processors or Calyso controllers to the CC-300 CORIOconsole via the IP connection or select SERIAL to control a single Video Processor via the serial cable.

5.4 Manual configuration of connection

Manual configuration of a connection is achieved by holding down the shift key and selecting a position using the soft key next to the required legend. For example, press shift and then press the key next to the screen where 'No Connection' is displayed. A connection configuration window will appear as shown in fig 7. We will set up the configuration for the C2-7100 in our example setup to illustrate the process.

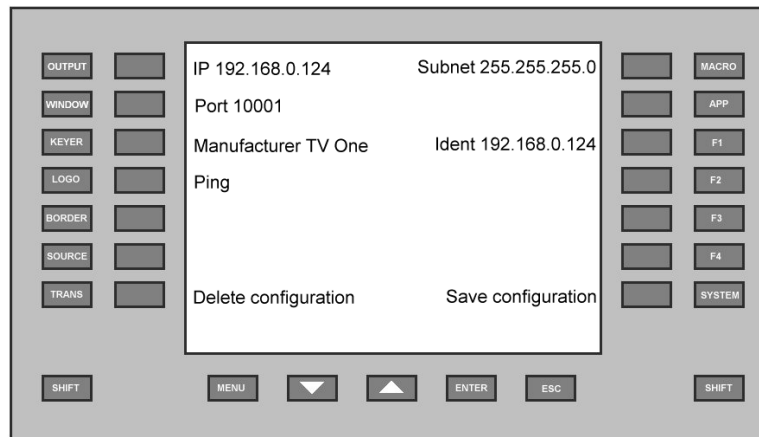

Fig 7. The connection configuration menu

The IP address, subnet & port settings can be changed using this menu. This is achieved by pressing the soft key next to the item to change. Flashing brackets will surround the item that will be altered which can then be changed using the up and down arrow keys as instructed in the status line at the bottom of the LCD display. Items with multiple values will shift to the next on each press of the soft key. The ENTER key will extinguish the brackets and set the value or the ESC key will extinguish the brackets and restore the original value.

The Ident key will attempt to find the name of the device if it is available by interrogating the network. For the Ident utility to work, the IP address & port settings must be correct. The units name will be displayed along with the last octet of the IP address in brackets as shown in fig 8..

CC-300 CORIOconsole Operation Manual

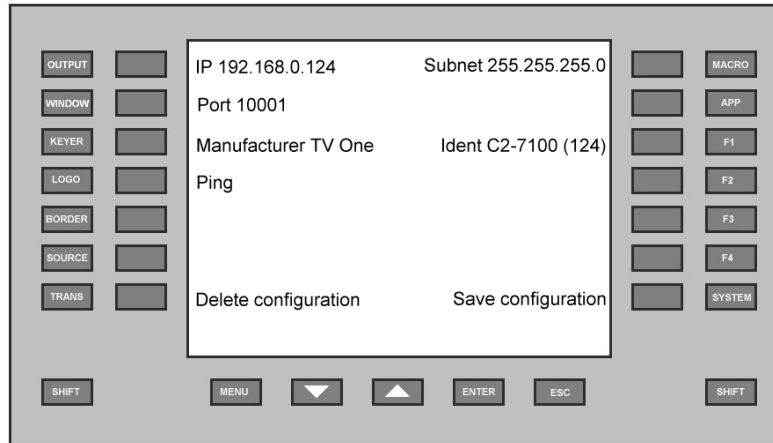

Fig 8. The Ident key has located a named unit.

If the ident is not available the full IP address is shown instead.

It is essential that the correct Manufacturer is set in this menu as this will effect what happens when a connection key is pressed.

The values set will not remain in the event of a power recycle unless the settings are made permanent by selecting 'Save configuration' and then press ENTER to confirm your choice.

Communication with the configured device can be tested by pressing the soft key for Ping, this will attempt to communicate with the configured device four times and the results will be displayed on the lower half of the LCD screen.

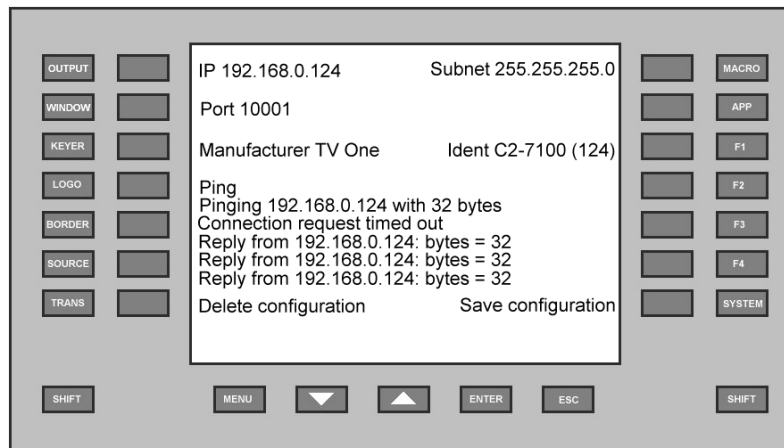

Fig 9. Result of a ping

The display will show a 'timed out' message after approximately five seconds if connection was not possible or a 'reply' message if successful. Once you are happy that the configuration data is correct, select Save configuration and then ENTER to confirm, this will make the changes permanent.

Should the connection be no longer needed it can be deleted by using the Delete configuration key and then ENTER to confirm. The deleted connection details may reappear in the event of a power recycle unless the settings are made permanent by selecting 'Save configuration' and then press ENTER to confirm your choice.

The ESC key will return you to the connection screen.

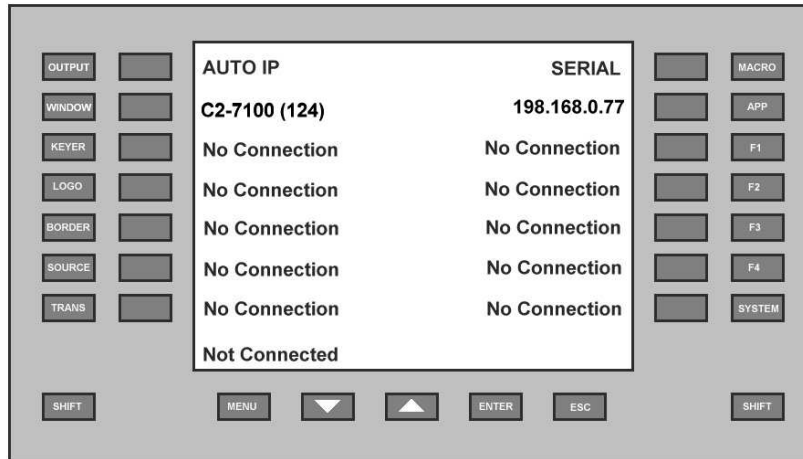

Fig 10 - The effect of using the ident key on the connection menu, Ident was used to name the C2-7100 but not the Calypso control unit.

5.5 Auto IP Detection

AUTO IP is a quick way to automatically set up the complete IP system. It will search the network and should detect all TV One video processors and Calypso controllers (with appropriate firmware) that are active. These are automatically assigned softkey locations and displayed on the connection menu.

On pressing the 'AUTO IP' key, a warning message is displayed that this action will remove all the current connection settings. Pressing ENTER will start the process. Messages will then be sent between the console, video processors and calypso control units exchanging settings which are used to set up the connection menu.

5.6 Calypso controller configuration

Set up the configuration for the Calypso control unit on the CC-300 CORIOconsole as explained in 5.4 or 5.5 above. Please refer to the Calypso controller instruction manual to configure and test database events. Press the softkey for the Calypso controller from the connection screen on the CC-300 CORIOconsole. A Trigger event window will appear.

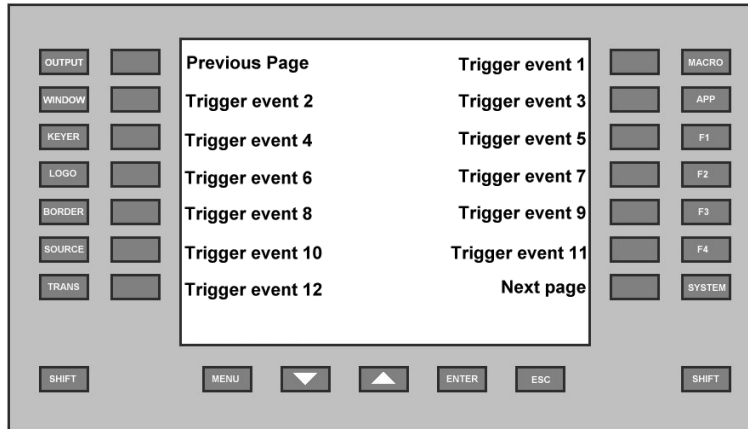

Fig 11 A trigger event window

There are eleven event screens containing 128 trigger events, these can be navigated using the Next and Previous page buttons. Find the screen which contains the trigger event which corresponds to the event stored in the Calypso database. Pressing the softkey next to that trigger event will send a trigger message via the Network to the calypso controller causing the event to take place. During this time the status of the communication is displayed on the bottom line of the LCD display.

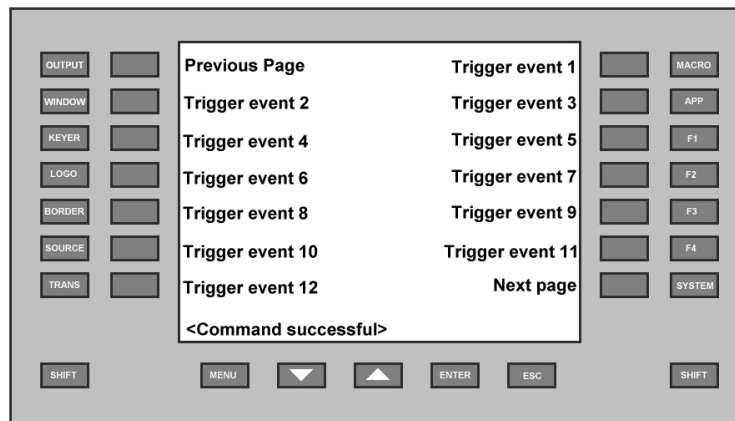

Fig 12 The effect of a successful trigger.

To trigger Calypso events when controlling a TV One video processor, a 'Hot Key' can be assigned to a trigger. To achieve this hold down the shift key and press the softkey for the trigger event number, a trigger event configuration menu for that trigger event is displayed.

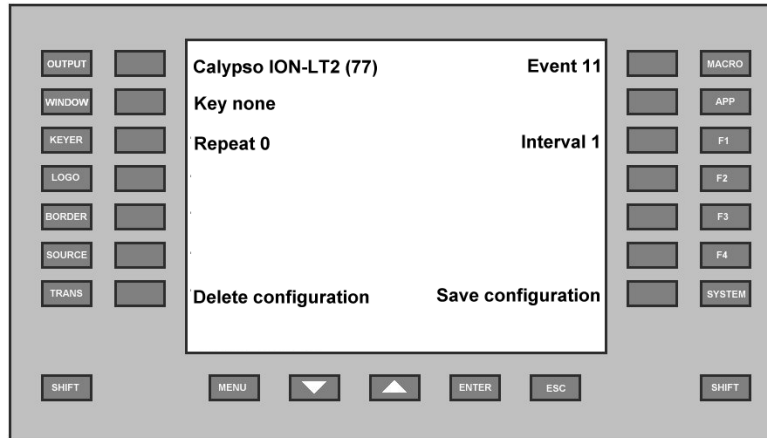

Fig 13 The Calypso trigger configuration menu.

A 'Hot key' can be assigned for quick execution of the trigger event. For the 'Hot Key' facility to work, the CC-300 CORIOconsole must be connected to a video processor unit.

To assign a 'Hot key', select the 'Key' softkey, then hold down the 'shift' key and select one of the outer Menu Keys in which you wish to assign the 'Hot Key' (Output, Window, Keyer, Logo, Border, Source, Trans, Macro, App, F1, F2, F3, F4, System). If the key has not already been assigned a message will appear indicating key assignment has been stored and pressing 'Enter' will place the key value on the LCD display.

If the command needs to be transmitted more than once, up to 15 repeats can be set and the interval between repeats can be selected in steps of 1/16 seconds. This can be achieved under the 'Repeat' and 'Interval' Legends. The key numbers assigned are:

OUTPUT	= 128,	MACRO	= 149,
WINDOW	= 129,	APP	= 150,
KEYER	= 130,	F1	= 151,
LOGO	= 131,	F2	= 152,
BORDER	= 132,	F3	= 153,
SOURCE	= 133,	F4	= 154,
TRANS	= 134,	SYSTEM	= 155

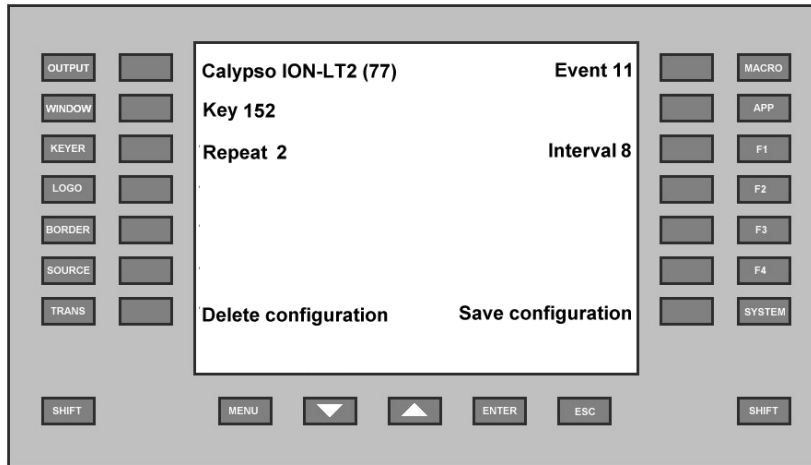

Fig 14. An example of the trigger event configuration menu showing that event 11 will be triggered 3 times (repeat twice) with a 0.5 second intervals when shift+F2 key is pressed.

Should the 'Hot key' no longer be needed it can be deleted by using the Delete configuration key and then ENTER to confirm, the settings may not remain in the event of a power recycle unless the settings are made permanent by selecting Save configuration and then press ENTER to confirm your choice.

The ESC key will return you to Trigger event menu.

Once a 'Hot key' is set, the trigger can be sent while connected to a TVOne video processor by holding the shift key + the key set (F2 in the above example).

5.7 Locking the keyboard

To prevent accidental key presses, all keys can be disabled by pressing both shift keys together. The legend 'KEYBOARD LOCKED' will be displayed as a reminder. Pressing both shift keys together again will unlock them, a message will appear in the lower right of the display to indicate that unlock has occurred.

5.8 Standby mode

The system menu has a standby softkey which will turn off all non essential functions and provide a low power standby mode. Pressing the 'Take' key will reset the unit and bring it back to the same state as a power recycle.

5.9 Connection problems?

When controlling a video processor by connecting over the network, it is sometime possible to have connection problems which are not always easy to discover what has happened. A connection has to be established between the devices before control can commence and this connection has to be terminated at the end to allow correct reconnection again.

The following information is provided in order to help solve common connection problems. Contact your network administrator for further help.

- 1. Keep Alive Counter.** In the system menu of the CC-300 CORIOconsole there is a KA: setting. This is a 'keep alive' counter. The video processor will always communicate with the CC-300 CORIOconsole at least every 45 seconds. Any message received will reset the keep alive counter to 60 seconds and this is then counted down towards zero. If a video processor were connected, this counter should count down to a minimum of 15 when it should return to 60 and count down again. In the absence of any communication from the processor for 60 seconds, (i.e. if the video processor were to be turned off while connected to the CC-300) this counter will reach zero after 1 minute and will then display a message (e.g. 'Lost connection to 192.168.1.124') on the status line of the LCD display. Esc will return to the connection menu in this case.
- 2. Console power loss while connected.** If the CC-300 CORIOconsole power were recycled while connected to a video processor, it will not be possible to re-connect immediately. The video processor will not be instantly aware of the lost connection to the CC-300 CORIOconsole and will continue to send 'keep alive' communications. If the CC-300 CORIOconsole receives such a communication from the video processor while it is not connected it will terminate the believed connection and give a short beep to indicate the connection is now available. In this event leave the CC-300 CORIOconsole for 1 minute before attempting to reconnect.
- 3. Unable to find target.** This will indicate that the initial search for the unit on the network did not find a device with the IP address supplied. Check the units are powered and the settings of both units.
- 4. TCP Handshake failed.** This normally means that a device with the IP address has been found but the connection to the device has not been successful in which case; check the Ethernet settings on both units. However the settings for a connection are stored within the CC-300 CORIOconsole following the first successful connection following a power cycle. If a connection has been established and then terminated, the video processor was then disconnected, the CC-300 CORIOconsole will not search for the device again when reconnecting, it will start to make connection by handshaking and if the device is no longer active this message will be displayed. Use standby to reset the unit and try to connect again to see if the status line at the bottom of the LCD shows 'Unable to find target' in which case follow the advice in (3) above.

CC-300 CORIOconsole Operation Manual

5. **Port value incorrect.** The video processor can indicate an incorrect port value during the connection process, if this happens this will be indicated on the status line at the bottom of the LCD. Recheck the port settings of the target in the connection configuration menu.

6. **Incorrect Manufacture.** The operation of the unit depends on the manufacturer set in the connection configuration menu. If a trigger event menu appears when trying to connect to a video processor or the status line shows 'Trying to connect' when selecting a Calypso controller, it is likely that the manufacturer has been set to the wrong value.

6.0 CC-300 IN OPERATION

6.1 Navigation

Upon connection to a scaler the top level menu for the specific scaler will be shown, for the case of a C2-7100 series unit the Mode menu is the only item shown.

By pressing the MENU key you will be returned to the top level menu for the current connected Video Processor. You can press the ESC key to navigate back through the menu items.

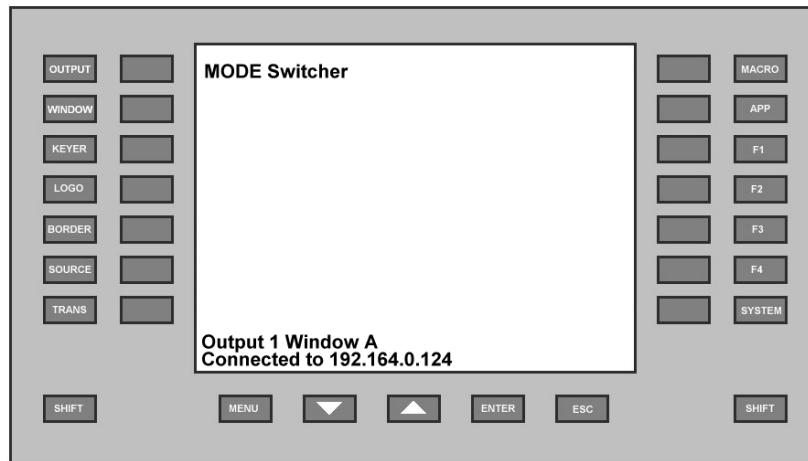

Fig 15. Top level menu when connected to the Video Processor

Select one of the fixed menu keys to view the adjustments available from the processor. To perform an adjustment press the soft key adjacent to the menu item, this will then show flashing brackets around the adjustable item. Adjustments to this item can then be made using the UP and DOWN arrow keys. Pressing the soft key adjacent to the menu item, the ENTER, or ESC key will finish the adjustment. In order to select another menu on the Video processor simply press the required fixed menu key, MENU and ESC will return you to the top level menu.

The Joystick can be used to perform adjustments of the Zoom, Shrink and Position values where applicable. Typically a left right movement of the Joystick will change values relating to Horizontal adjustments and up down movements will change values relating to Vertical adjustments.

The CC-300 CORIOconsole makes the operation of the menu driven video processor more convenient, please refer to the video processor manual for detailed operation of the features.

7.0 RETURN PROCEDURE

Before returning the Processor for repair, there are several checks you can make yourself to make sure the problem is actually caused by a failure.

Are you sure there's a fault?

Many 'faults' are due to incorrect set-up or use, so a simple checklist is provided below to help you identify potential problems.

Set the unit up with your equipment as described in this manual and run through the checklist. This will hopefully determine whether or not the unit is actually faulty and prevent units from being returned unnecessarily.

Check the connection problem tips in Section 5.9 of this manual and check out the various FAQ (Frequently Asked Questions) listings on the support website, <http://www.tvone.com/support> which shows the latest Hints, Tips and Solutions.

Don't presume it is the CC-300 CORIOconsole that is causing the problem. Check that the equipment being used with it is fully working and setup correctly.

First, check the AC power. Is it present and is the unit turned on? Check that all cables are properly plugged in and are not damaged and then make certain that all equipment connected to the Processor is working properly.

Perhaps you have a "frozen" CC-300 CORIOconsole and you cannot exit from the current task. In that case, recycle the power, choose restore defaults from the system menu to do a 'Factory Reset' of the product and follow the instructions in this manual from the start. Allow five minutes before reconnecting to allow all the network connections to time out.

7.1 To return a unit for repair

First contact TV One using the <http://www.tvone.com/support> website. Support personnel will determine whether a return to the factory is the appropriate solution. If that's the case, a Return Authorization Number will be issued. You should provide the following information for each unit:

Product type

Serial number of the faulty unit (this is on the underside of the unit)

Full details of fault

Invoice number (if available)

Units should be returned via insured carrier or registered mail (thus allowing a trace to be made if the Processor is lost in transit), with shipping costs and insurance arranged at your own risk and expense. Goods in transit are the responsibility of the sender and the supplier will not be responsible for transit losses.

Please clearly state the return number on the outside packaging and on any accompanying documentation. This will greatly speed up processing.

IMPORTANT: DO NOT return a unit for warranty repair without first obtaining a Return Authorization Number. No action will be taken on a unit returned in warranty for repair without a Return Authorization Number.

7.2 TECHNICAL SUPPORT

If problems are experienced, please read through the symptom topics below in order to resolve the problem. After doing so, if you still need to contact Technical Support at <http://www.tvone.com/support> please have the following handy:

Details of the problem:

- Whether the problem happens only at specific times or has only just started occurring (and what other things have changed at the same time).
- Firmware revision numbers - found in the System menu.

8.0 WARRANTY POLICY

LIMITED WARRANTY – With the exceptions noted in the next paragraph, TV One warrants the original purchaser that the equipment it manufactures or sells will be free from defects in materials and workmanship for a period of two years from the date of purchase. Should this product, in TV One's opinion, prove defective within this warranty period, TV One, at its option, will repair or replace this product without charge. Any defective parts replaced become the property of TV One. This warranty does not apply to those products which have been damaged due to accident, unauthorized alterations, improper repair, modifications, inadequate maintenance and care, or use in any manner for which the product was not originally intended.

Items integrated into TV One products that are made by other manufacturers, notably computer hard drives and liquid crystal display panels, are limited to the term of the warranty offered by the respective manufacturers. Such specific warranties are available upon request to TV One.

If repairs are necessary under this warranty policy, the original purchaser must obtain a Return Authorization Number from TV One and return the product to a location designated by TV One, freight prepaid. After repairs are complete, the product will be returned, freight prepaid.

LIMITATIONS - All products sold are "as is" and the above Limited Warranty is in lieu of all other warranties for this product, expressed or implied, and is strictly limited to two years from the date of purchase. TV One assumes no liability to distributors, resellers or end-users or any third parties for any loss of use, revenue or profit.

TV One makes no other representation of warranty as to fitness for the purpose or merchantability or otherwise in respect of any of the products sold. The liability of TV One with respect to any defective products will be limited to the repair or replacement of such products. In no event shall TV One be responsible or liable for any damage arising from the use of such defective products whether such damages be direct, indirect, consequential or otherwise, and whether such damages are incurred by the reseller, end-user or any third party.

9.0 CONNECTOR PINOUTS

9.1 Ethernet connector

9.1.1 Straight through cable

RJ-45 PIN	RJ-45 PIN
1 Tx+	1 Rc+
2 Tx-	2 Rc-
3 Rc+	3 Tx+
6 Rc-	6 Tx-

9.1.2 Crossover cable

RJ-45 PIN	RJ-45 PIN
1 Rx+	3 Tx+
2 Rc-	6 Tx-
3 Tx+	1 Rc+
6 Tx-	2 Rc-

9.2 Power connector

PIN	Function
Center	12V
Outside	0V

9.3 RS232 / DB9 connector

Pin	Function
1	N/C
2	RX (Receive data)
3	TX (Transmit data)
4	N/C
5	GND (Signal return)
6	N/C
7	RTS (Request to send)
8	CTS (Clear to send)
9	N/C

10.0 SPECIFICATION

10.1 Control Methods

Local Front Panel 10 Programmable Buttons & Shift key + LEDs, Rotary Encoder knob, and LCD
RS-232 Interface DB-9 Male Connector
Ethernet Interface RJ45 Connector
Expansion Option Control Via D-15 Options Connector from the Main Unit

10.2 Mechanical

Desktop Case (HWD) 1.75x17x7.9" (44x420x200mm)
With Rack Ears (HWD) 1.75x19x7.9" (44x482x200mm)
Weight (Net) 7lb 5oz (3.3kgms)

10.3 Environmental

Operating Temperature 0° to +45° C (+32° to +113° F)
Operating Humidity 10% to 85%, Non-condensing
Storage Temperature -10° to +60° C (+14° to +140° F)
Storage Humidity 10% to 85%, Non-condensing

11.0 CONTACT INFORMATION

Should you have any questions or require assistance with this product in areas not covered by this manual, please contact TV One at the appropriate location shown below:

TV One USA

1350 Jamike Drive
Erlanger, KY 41018
USA
Tel 859-282-7303
Fax 859-282-8225
sales@tvone.com
www.tvone.com

TV One Asia

11F, No. 28, Sec. 2
San-Min Road, Panchiao City
Taipei Hsien 220
Taiwan ROC
Tel +886 2 8951-0674
Fax +886 2 8951-0675
sales.asia@tvone.com
www.tvoneasia.com

TV One Latin America

2790 NW 79 Avenue
Miami, FL 33122
USA
Tel 305-418-9305
Fax 305-418-9306
sales.latinoamerica@tvone.com
www.tvonela.com

TV One Europe

Continental Approach
Westwood Industrial Estate
Margate, Kent CT9 4JG, UK
Tel +44 (0)1843 873311
Fax +44 (0)1843 873312
sales.europe@tvone.com
www.tvone.co.uk

TV One China

Room 1007, Golden Peach Building
No.1900 Shangcheng Road
Pudong, Shanghai,
China 200120
Tel +86 21 5830-2960
Fax +86 21 5851-7949
sales.china@tvone.com
www.tvonechina.com

TV One Mercosur

Honduras 5849 2nd Floor Office C
(C1414BNI) Capital Federal
Buenos Aires, Argentina
Tel +54 11 4771-5570
Fax +54 11 4771-5570
sales.mercosur@tvone.com
www.tvonela.com

